

Junction Boxes

Leading Edge Design

Time saving installations are made possible with Alderon's ready-made junction boxes. Flexible sizes allow for different diameter pump cables and hub sizes. Use Alderon's junction boxes for pumping stations, on-site septic systems and other electrical installations.



Specifications

Material: PVC	External Enclosure Size:	Internal Volume:
Environment Rating: 4X	4 x 4 x 4 inches	50.65 inches
Mounting: External	6 x 6 x 4 inches	144.00 inches
Mounting Feet	8 x 8 x 4 inches	261.14 inches

Installation Notes

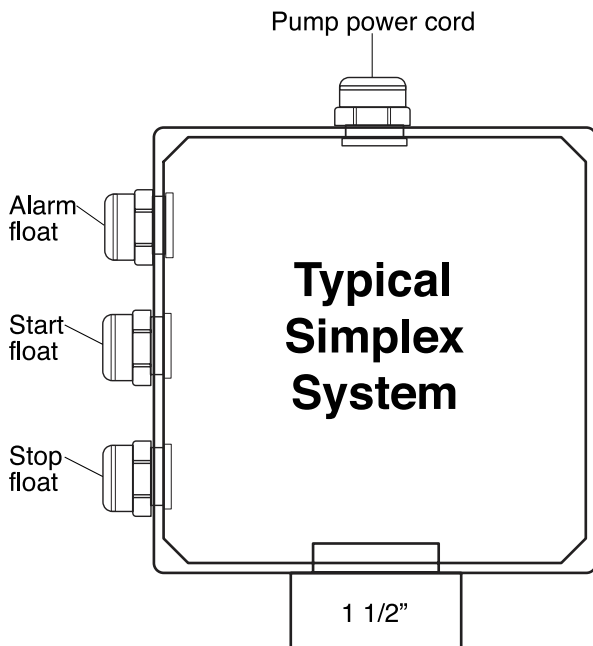

Wiring to control panel

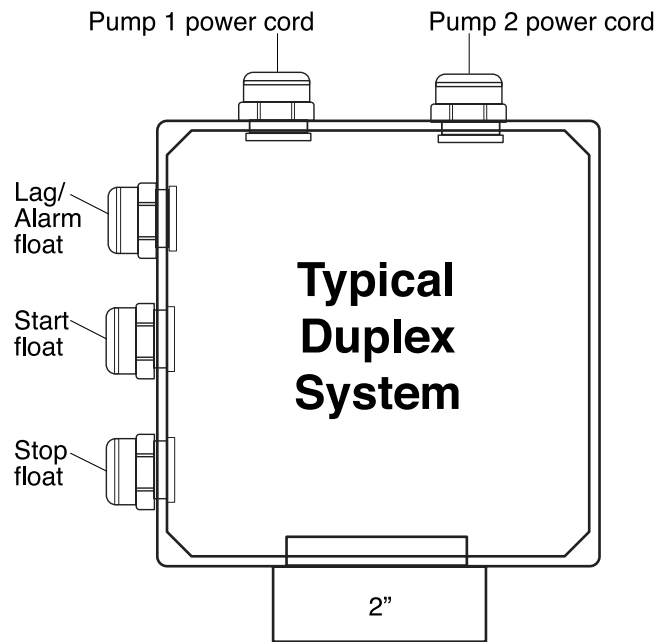

Wiring to control panel



Leading Edge Control Products

Alarm Systems

Control Panels





Float Switches

Leak Detection Systems

Junction Boxes

Order Numbers

Accessories — Junction Boxes

Part Number	Description	 4" x 4" x 4" Junction Box	 4" x 4" x 4" Junction Box with Cable Connectors and Hub	 6" x 6" x 4" Junction Box	 6" x 6" x 4" Junction Box with Cable Connectors and Hub	 8" x 8" x 4" Junction Box
7093	4"X4"X4" Junction Box (JB) Only	X				
7094	4"X4"X4" JB, 1.5" Hub, 2 Float Grips, 1 Pump Grip 0.2" - 0.47"		X			
7095	4"X4"X4" JB, 1.5" Hub, 3 Float Grips, 1 Pump Grip 0.2" - 0.47"		X			
7096	6"X6"X4" Junction Box (JB) Only			X		
7097	6"X6"X4" JB, 1.5" Hub, 3 Float Grips, 1 Pump Grip 0.2" - 0.47"				X	
7098	6"X6"X4" JB, 2" Hub, 3 Float Grips, 1 Pump Grip 0.35" - 0.71"				X	
7099	6"X6"X4" JB, 2" Hub, 3 Float Grips, 2 Pump Grips 0.2" - 0.47"				X	
7100	6"X6"X4" JB, 2" Hub, 3 Float Grips, 2 Pump Grips 0.35" - 0.71"				X	
7101	8"X8"X4" Junction Box (JB) Only					X
F	Optional extra float grip for "four" float systems – place "F" after part number					

Accessories — Custom Junction Boxes

Junction Box	Size	Hub	Number of Float Grip(s)	Pump Grip(s)	Pump Cable Diameter Size
J		H	F	P	
	6=6"x6"x4"	1 = 1"	2 = 2 grips	A,B,C is for Simplex	A = 0.2 - 0.47 diameter
	8=8"x8"x4"	1.5 = 1.5"	3 = 3 grips		B = 0.35 - 0.71 diameter
		2 = 2"	4 = 4 grips	D,E,F is for Duplex	C = 0.55 - 0.98 diameter
					D = 0.2 - 0.47 diameter
					E = 0.35 - 0.71 diameter
					F = 0.55 - 0.98 diameter

EXAMPLE: J6H1F3PA

